Part III Technical Rules common

Version 1 Dec, 2023. (All elder regulations are not valid). Only the version published on the www.eurotrial.eu website is valid.

These are technical rules and regulations for Eurotrial Championship for 2019 to 2023, and they are closed for this period of time.

In case of severe security risks, apparent errors in the regulation or unsportsmanship caused by a loophole of the rules, changes will be made by Eurotrial committee.

Changes in the regulation is done in red color and underlined, old text that is not valid is with blue text with line through.

Those rules apply together with “Part III Technical rules – tech rules current class”.

3.1 Permissible vehicles - approval

3.1.1 Permitted vehicles

Only four-wheel-drive vehicles may participate in the competitions. For groups O, S and M, at least 50 identical vehicles must have been produced worldwide, and if there is any doubt about this or if the vehicle meet's the specifications, it is the owner's responsibility to proof this.

Quad and ATV are not permitted.

3.1.2 Classes

There are five groups you may participate in:

- Trial group O (original / original vehicles)
- Trial group S (standard / series vehicles)
- Trial group M (modified / improved series vehicles)
- Trial group PM (Pro modified / improved vehicles)
- Trial group P (prototypes)

3.1.3 Weight

The vehicle gross weight must not exceed 3500kg.

3.2 Safety regulations

3.2.1

To participate in Eurotrial, the vehicle must meet the Eurotrial safety regulations.

Changes of the vehicle are not allowed after technical inspection. Change to spare tire must be checked by technical inspection if it's another type or dimension.

3.2.2 Helmets

Passenger helmets must be worn in all groups and sections. The helmet must be designed for motorsport use.

3.2.3 Driving-suite

The driver and co-driver must wear a protective suit or an overall in all sections. Non fire-proofed overalls must be made from cotton.

3.2.4 Intercom

Intercom between driver and co-driver is allowed, all type of wireless systems is not allowed

3.2.5 Parking/emergency brake

The parking brake must be able to keep the vehicle stationary on a slope with 16 degrees inclination. The emergency must be able to stop a moving car in an effective way.

During the brake test, there will be a marshal sitting in the car to ensure that the vehicle is in 2WD, and that the driver don't use main brake system during the test of the emergency brake system.

Additional testing of the braking system can occur during the competition.

If a vehicle is picked out for a additional brake test when it is standing in line for the last section, and time runs out, the driver is allowed to drive the section after the testing, if the car is ok.

3.2.6 Main circuit breaker

Marking for main breaker.



3.2.7 Safety cage/roll cage

3.2.7.1 Construction

Multi-tubular structure installed in the cockpit with the function to reduce the deformation of the passenger area in case of an impact or rollover.

Open Vehicles (all vehicles without original metal roof).

All open vehicles in all classes must have a fully welded rollcage that meets the minimum-requirements in each class.

Vehicles in class O and S with internal rollcage and original metal roof may use bolted connections.

The removable connections complying to drawing 1 or 2 must be used for joining the upper parts of the main rollbar, the front rollbar and the lateral half-rollbars. Maximum four removable connections are allowed in the basic structure 3.2.6.4

Rollcage with two lateral rollbars are not allowed. Connection type 1 must have at least 4 bolts with minimum size of M8 and at least ISO standard 8.8 or higher. Connection type 2 must have at least 2 bolts with minimum size of M8 and at least ISO standard 8.8 or higher.

Removable connections complying with drawings 3 or 4 are only valid for attaching roof reinforcement 3.2.6.7 and optional members, and are forbidden for joining the upper parts of the main rollbar, the front rollbar and the lateral half-rollbars. Connection type 3 or 4 must have a bolt with minimum size of M10 and at least ISO standard 8.8 or higher.

All removable connections must be fitted within the extension of the axis of the tubes, and may not be offset. They must not be welded once assembled.

B-bar, diagonal member and backstays must always be welded together.

Only allowed for original metal roof vehicles in class O and S.

Vehicles in class O and S with a combined internal and external rollcage may use bolted connection-plates at two positions on the roof at the B-bar, making the connection through the roof (as the rollcage itself does not pass through the roof) and therefore joining the two systems together. The connection-plates at the roof must sandwich the roof between the outer and inner rollcage and must be maximum 100cm² and have a minimum thickness of 3mm each. They must be welded to the outer and inner rollcage and then bolted together, through the roof, with at least 4 bolts each with minimum size of M8 and at least ISO standard 8.8 or higher. A maximum distance of 15mm between the tube outer circumference and the bolt head is allowed.

Only allowed for original metal roof vehicles in class O and S.

Vehicles in all classes with a external B-bar.

The external B-bar must be welded or bolted to a reinforcement plate, or a tube at the sill with minimum the same size as the B-bar. If the B-bar is connected to a tube at the sill, this tube must be welded or bolted to a welded reinforcement plate at the sill This reinforcement plate must be minimum 150cm² and 3 mm thick and it is recommended that it is L-shaped to distribute the forces evenly in the sill. There must also be a reinforcement tube between the reinforcement plate and the frame.

External A-bar/lateral halfbar must be fitted to the body with a reinforcement plate in the upper corners in the front of the windscreen, or to the reinforcement-plate/tube at the sill. If the A-bar is mounted in the sill the reinforcement plate must be minimum 150cm² and 3 mm thick and it is recommended that it is L-shaped to distribute the forces evenly in the sill.

The sill may not have any form of rust in the area where the reinforcement plate attached.

3.2.7.2 Specification of parts in the rollcage

Rollbar

Tubular frame forming a hoop with two mounting feet.

B-bar, main bar

Structure, consisting of a nearly 90 degree tube, who is mounted crosswise in the vehicle. With an upright sitting position the helmet and shoulders must be in front of the B-bar outer dimension.

The B-bar must be bent and made from one piece of steel tube.

B-bar, diagonal member and backstays must always be welded together.

A-bar, front bar

Similarly as the B-bar, however it should follow the outer windscreen holders, as well as the upper edge of the windscreen. The A-bar must be bent and made from one piece of steel tube.

Lateral rollbar

Near-longitudinal and near-vertical single piece tubular hoop located along the right or left side of the vehicle, the front pillar of which follows the windscreen pillar and the rear pillar of which is near-

vertical and located just behind the front seats. Each lateral rollbar must be bent and made from one piece of steel tube.

Lateral half-rollbar

Identical to the lateral rollbar but without the rear pillar. Each half-lateral rollbar must be bent and made from one piece of steel tube.

Longitudinal member

Near-longitudinal tube joining the upper parts of the A-bar and B-bar.

Transversal member

Near-transversal tube joining the upper parts of the lateral half-rollbars or of the lateral rollbars.

Diagonal member

Transversal tube between one of the top corners of the B-bar, or one of the ends of the transversal member in the case of a lateral rollbar, and the lower mounting point on the opposite side of the rollbar. or the upper end of a backstay and the lower mounting point of the other backstay. B-bar, diagonal member and backstays must be welded together.

Backstay

Longitudinal tube between the top corners of the B-bar, or one of the ends of the transversal member, in the case of a lateral rollbar, and the rear of the vehicle. B-bar, diagonal member and backstays must be welded together.

Doorbar

Mandatory for all vehicles in class Pm and P.

A minimum of one longitudinal member must be fitted on each side of the vehicle. The lateral protection must be as high as possible, and if using a single bar, at least 10 cm from the bottom of the seat at the hip. The purpose of the doorbar is to protect the driver's and co-driver's hips in the event of rollover. For competitors without a co-driver, doorbars only need to be fitted on the driver's side. Single-seaters must have doorbars on each side. The doorbar must be welded to the rollcage and/or frame.

There must also be some kind of net and/or tube that prevent the lower parts of the leg from falling outside the vehicle in the event of a rollover. This net/tube can be part of a door and may be able to open.

Roof reinforcement

One, two or more tubes which runs diagonally across the roof, from one corner of the cage to the other corner of the cage, or two tubes in the shape of a cross or in the shape of a V. If the car have one tube which runs longitudinal from one of the highest points of the B-bar to the other side of the A-bar, this construction must also be reinforced in each corner. See 3.2.6.7

A space of at least five cm between the helmet and the tubes is recommended.

Padding

The distance between driver/codriver and any part of the rollcage is recommended to be at least 50mm. If the distance is less than 50mm, the tubes must be covered with shock absorbing protective padding. The thickness of the padding must be minimum 10mm.

Mounting foot

Plate welded to the end of a rollbar tube, to permit its bolting and/or welding to the bodyshell/chassis, usually onto a reinforcement plate. Jeep YJ/TJ original B-bar mounting feet need no reinforcement plate as the construction is known and strong enough in the original.

Reinforcement plate

3 mm steel plate fixed to the bodyshell/chassis under a rollbar mounting foot in order to more efficiently distribute the load onto the bodyshell/chassis. The minimum area of the plate must be 100cm². The steel plate must be fitted with screws or welded to the body. When the steel plate is screwed to the body, a same size, or bigger counterplate must be used. The plate must be attached with at least 4 screws of minimum size M8, at least ISO standard 8.8, or welded to the body. For vehicles with a plastic car body, the bars / rollcage must be attached to the frame. If the rollcage is welded to the frame, and the material thickness of the frame is 3 mm or more, no reinforcement plate is needed.

Roof

The roof space between the A and the B bars must be covered with a steel plate with a minimum thickness of 2 mm, or an aluminum plate with a minimum thickness of 3 mm.

The plate must be fitted with screws in at least six points (quantity M8, ISO standard 8.8) or welded with a minimum of six welding seams, each with a minimum length of 5 cm. If the roof is attached with screws, **these must be mounted in fixing plates or it's recommended to use** mounting lugs welded to the rollcage. Mounting thru the tubes is **forbidden not recommended**. The minimum requirement is one seam/screw in each corner of the roof, one in the middle of the A-bar and one in the middle of the B-bar.

A space of at least five cm between helmet and plate is recommended.

Bending tubes

The tubing must be bent by a cold working process and the centerline bend radius must be at least 3 times the tube diameter. If the tubing is ovalised during bending, the ratio of minor to major diameter must be 0,9 or greater. The surface at the level of the bends must be smooth and even, without ripples or cracks.

If technical inspection consider that a bend isn't safe, they can demand that the driver has to weld a reinforcement like a gusset or a additional tube.

Welding

All required tubes, members and mounting foot of the basic structure 3.2.6.4, diagonal member 3.2.6.6 and roof reinforcement 3.2.6.7 must be welded together in all open vehicles regardless of class. In class M, Pm and P all parts of the rollcages must be welded.

All welds should be of the highest possible quality with full penetration of the tubes, and preferably using a gas-shielded arc. The weld must be implemented along the entire tube diameter.

Although good external appearance of a weld does not necessarily guarantee its quality, poor looking welds are never a sign of good workmanship.

Additional safety bars/tubes

Additional tubes/bars, for example doorbars, windscreen pillar reinforcement and similar, are allowed. No specifications regarding the construction or dimension of additional tubes/bars. All additional tubes are allowed to be attached with removable connections.

3.2.7.3 Tube dimension

For all constructions the minimum dimension is 38 x 2.5 mm (1,5"x0,095") or 40 x 2.0mm (1,6"x0,083"). Only constructions made from steel tube are allowed.

It's strongly recommended in case of replacing the B-bar/main-bar, a major repair of the cage or at new construction, to use cold drawn seamless unalloyed carbon steel tubes with a minimum tensile strength of 350 N/mm. Recommended tube size are 45x2,5mm (1,75"x0,095") or 50x2,0mm (2,0"x0,083") for the B-bar. Also recommended for A-bar/front-bar, lateral rollbar, half-lateral rollbar and transversal member.

It is forbidden to drill holes in any tubes that are part of 3.2.7.4 Basic structure, 3.2.7.5 Doorbars, 3.2.7.6 Diagonal member and 3.2.7.7 Roof reinforcement.

3.2.6.4

No tubes included in the rollcage are allowed to be used as a container for any kind of liquid or gas.

3.2.6.5 Other constructions of rollcage

Other designs than those listed below can be approved if they are professionally built and where their strength, and durability are well known.

Dispensation can be given for these structures after consulting technical manager.

3.2.7.4 Basic structure must be made according to one of the following designs

One B-bar
one A-bar
two longitudinal members
two backstays
six mounting feet

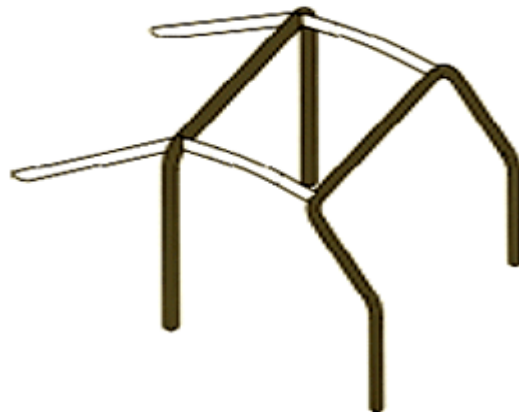

One B-bar
 Two lateral half-rollbars
 one transversal member
 two backstays
 six mounting feet

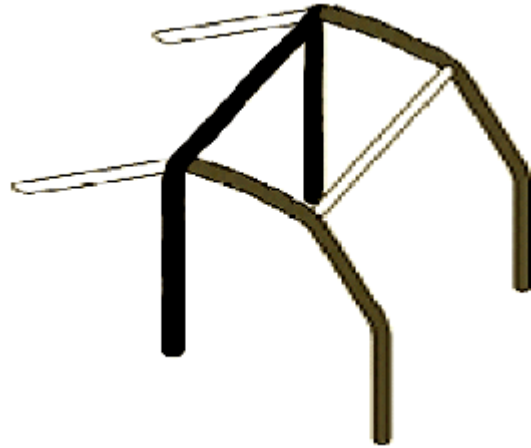

Two lateral rollbars
 two transversal members
 two backstays
 six mounting feet
 With this construction the diagonal member must be made double as a cross, right behind the seats.

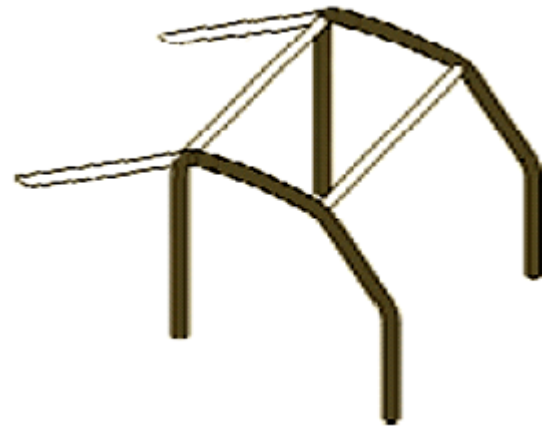

Two lateral rollbars
 two transversal members
 two B-bar stands
 six mounting feet
 With this construction the diagonal member must be made double as a cross, right behind the seats.



3.2.7.5 Doorbars:

At least one longitudinal tube must be fitted on each side of the vehicle.

The tube(s) making up this protection must be welded into the rollcage in the rear.

The design may be a single tube or a double like a cross.

SHAPED.

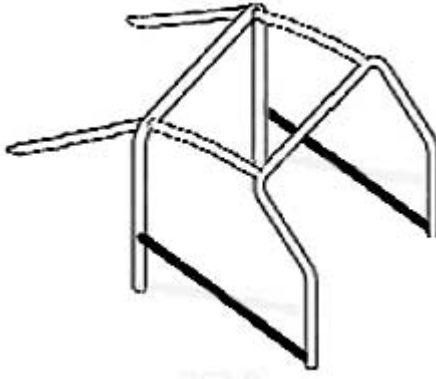

SHAPED.

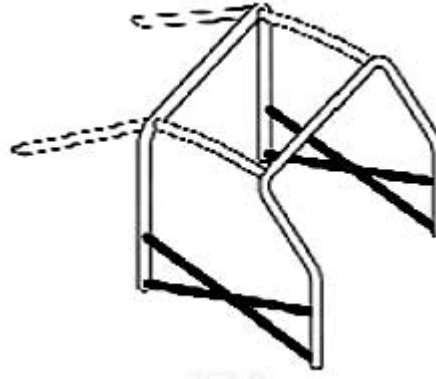

3.2.7.6 Diagonal member:

The cage must have one of the diagonal members shown on following drawing.

The orientation of the diagonal member be reversed, and made double as a cross.

Members must be straight.

Diagonal member may also be mounted in the B-bar.

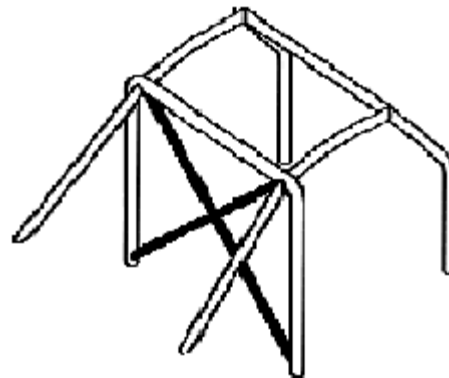
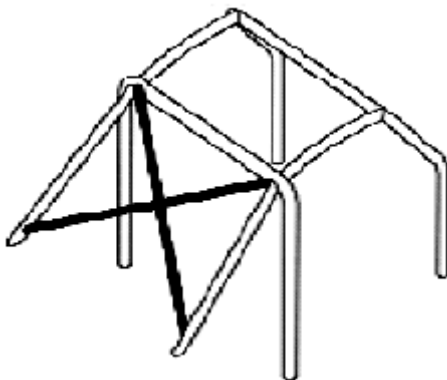
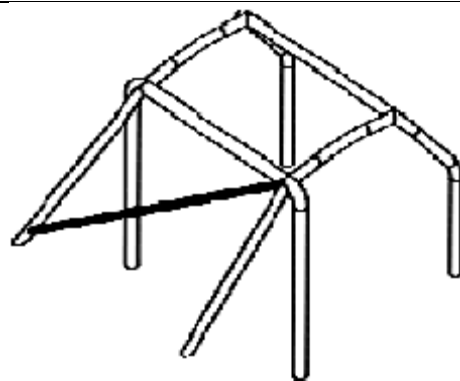

Diagonal member may also be designed as an inverted V, but then must also the roof reinforcement be shaped like a V.

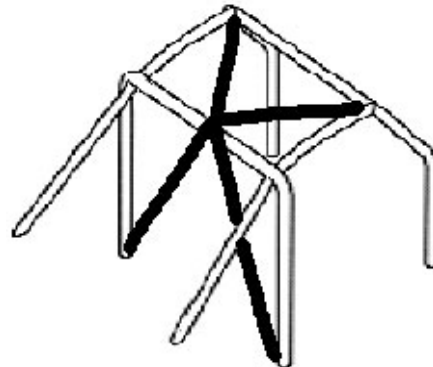

3.2.7.7 Roof reinforcement:

The upper part of the safety cage must comply with one of following roof reinforcement examples.

The reinforcements may follow the curve of the roof.

The orientation of the diagonal tube may be reversed, mirrored and made double as a cross.

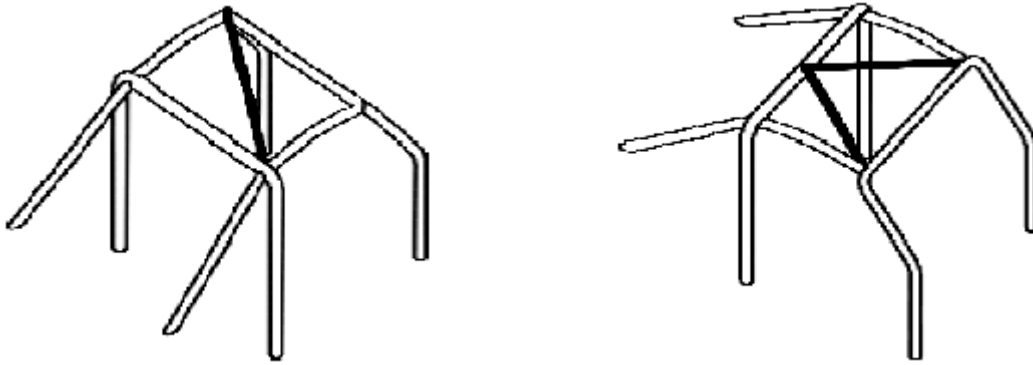

Tube which runs longitudinal from one of the highest points of the B-bar to the other side of the A-bar, must also be reinforced in each corner according to the drawing beside.

A space of minimum five cm between helmet and tubes is recommended.

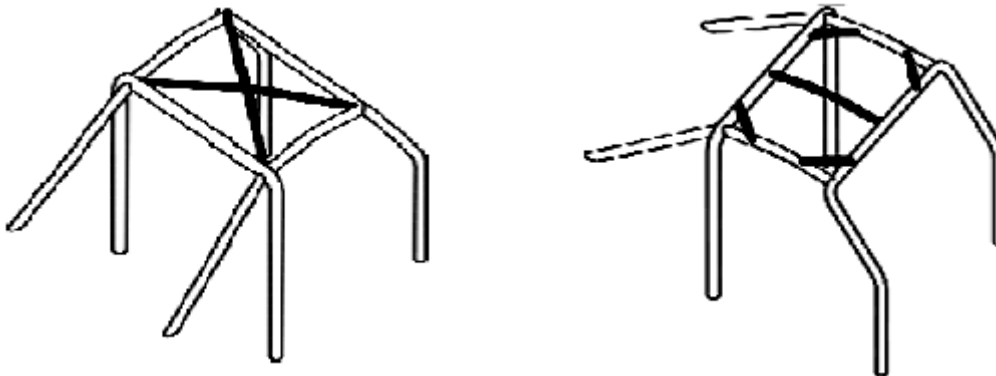
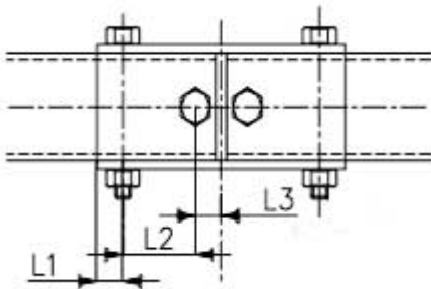
**3.2.7.8 Removable connections:**

The removable connections type 1 (left) and 2 (left under & under) must be used for joining the upper parts of the main rollbar, the front rollbar and the lateral half-rollbars together.

Only allowed for original metal roof vehicles in class O and S.

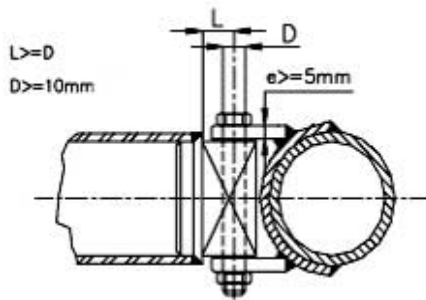
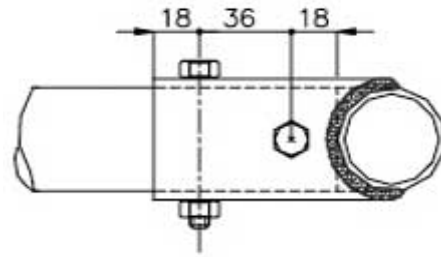
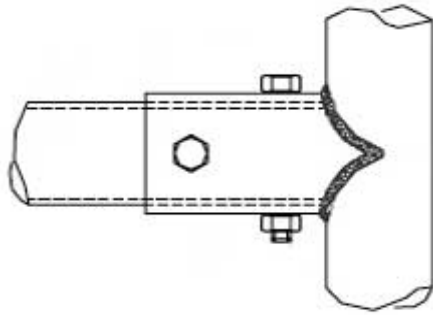

The removable connection type 3 (left) and type 4 (under) are only allowed for attaching roof reinforcement and optional members, and are forbidden for joining the upper parts of the main rollbar, the front rollbar and the lateral half-rollbars together.

Only allowed for original metal roof vehicles in class O and S.

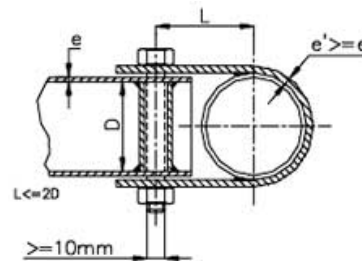

3.3 Environment

3.3.1 General information

Cars competing in Eurotrial should be built in a way that all forms of leakage (especially of oil and fuel) is reduced to a minimum.

3.3.2 Exhaust emissions

3.3.2.1 Diesel engines

Diesel engines may not be "tuned" so that they are at full throttle smoke too much.

Technicians at the inspection can make a visual assessment of a diesel engine exhaust emissions. This may only be made with the engine at normal operating temperature, and is done by depressing the accelerator pedal to a maximum, and then release it before the engine reaches its maximum speed. Even after the race started, a car can be taken out of the race if it is deemed too dirty in the exhaust.

3.3.3 Leakage

3.3.3.1

Small oil leakage, moisture, and occasional drops are acceptable.

In the event of large oil leaks occurring in the sketch during the competition, the official can stop the clock and point out to the driver that it is leaking. If the driver wants, he can complete the section.